

# Hydrogen pro

**Pareto Securities' Power & Renewable Energy Conference**

28 February 2023



# Disclaimer

The following applies to this document, the oral presentation of the information in this document, and any question-and-answer session that follows the oral presentation (collectively, the “Information”). By receiving and/or attending a meeting where this presentation is made and in accessing the Information, you agree to be bound by the terms and conditions and limitations set out herein. This presentation (the “Company Presentation”) has been prepared by HydrogenPro ASA (the “Company”).

The Company Presentation is strictly confidential and may not be reproduced, redistributed, published or passed on to any other person, directly or indirectly, in whole or in part. If this document has been received in error, it must be returned immediately to the Company.

The Company Presentation and any information provided is only preliminary and indicative and does not purport to contain the information that would be required to evaluate the Company. The Company Presentation and the Information does not constitute or form part of, and should not be construed as, an offer, solicitation or invitation to subscribe for, underwrite or otherwise acquire, any securities of the Company.

The Company Presentation have been prepared for the exclusive use of persons attending an oral briefing and meeting to which these materials relate given by a representative of the Company and/or persons to whom these materials have been provided directly by an authorized representative of the Company. Further, the materials are strictly confidential and by reviewing it, you acknowledge its confidential nature and agree to the terms of this notice. The materials may not be copied, distributed, reproduced, published or passed on, directly or indirectly, in whole or in part, or disclosed by any recipient, to any other person (whether within or outside such person's organization or firm) by any medium or in any form for any purpose.

**No liability:** The Company Presentation has been prepared by the Company. The Company does not accept any responsibility whatsoever, or make any representation or warranty, express or implied, for the contents of the Company Presentation, including its accuracy, completeness or verification or for any other statement made or purported to be made in connection therewith the Company. The information in this Company Presentation and any other material discussed is subject to change.

Any forward-looking statements contained in this Company Presentation, including assumptions, opinions and views of the Company or cited from third party sources, are solely opinions and forecasts and are subject to risks, uncertainties and other factors that may cause actual results and events to be materially different from those expected or implied by the forward-looking statements. The Company does not provide any assurance that the assumptions underlying such statements are free from errors nor accept any responsibility for the future accuracy of opinions expressed herein or as part of the Information, or the actual occurrence of forecasted developments.

Except where otherwise expressly indicated, this Company Presentation speaks as of the date set out on its cover. The delivery of this Company Presentation shall, under no circumstances, be construed to indicate or imply that there has been no change in the affairs of the Company since the date hereof. The Company does not assume any obligation to update or revise the Company Presentation or the Information.

The Company Presentation is subject to Norwegian law, and any dispute arising in respect of thereof is subject to the exclusive jurisdiction of Norwegian courts with Oslo District Court as first venue.



# Agenda

- I. Highlights
- II. Becoming #1 provider of large-scale green hydrogen plants
- III. Summary
- IV. Appendix





# I. Highlights

Hydrogen pro

# Quarterly highlights

1

**Proof of concept for the world's largest single stack electrolyser**

2

**300 MW manufacturing facility upgraded and scaled to deliver on purchase orders**

3

**HydrogenPro's partner DG Fuels has secured off-take for 100% at the SAF plant in Louisiana, US with electrolyser requirements of ~840MW**

4

**Progressing on delivery to ACES<sup>1</sup> project: the world's largest green hydrogen energy hub**

1) Advanced Clean Energy Storage



# Setting a new industry standard

- The initial test of the world's largest high-pressure alkaline electrolyser at the Herøya Industrial Park located in Porsgrunn, Norway is completed
- Our single 5,5 megawatt (MW) electrolyser has been validated to produce 1,100 Nm<sup>3</sup>/h hydrogen at normal current density. This equals 100 kg of pure green pressurised hydrogen per hour, which sets a new standard for the industry
- The test provides proof-of-concept that our electrolyser and gas separator technologies will produce hydrogen on a large scale
- Further testing to optimise electrolyser efficiency on-going



*HQ and test center at Herøya, Porsgrunn*

# HydrogenPro has grown >10x since IPO (October 2020)

	IPO (October 2020)	Q4 2022
Value chain position	Distributor	Technology owner & OEM
Manufacturing capacity (p.a.)	0 MW	300 MW
Backlog	NOK 15 mill	NOK 747 mill
Active sales pipeline	1.5 GW	18.5 GW
# of employees	10	165 <sup>1</sup>
Listing venue	Euronext Growth	Oslo Børs main market

1) As of 7 February 2023

# Strong foundation for further growth

## Key priorities 2023

### HydrogenPro has grown >10x since IPO (October 2020)

	IPO (October 2020)	Q4 2022
Value chain position	Distributor	Technology owner & OEM
Manufacturing capacity (p.a.)	0 MW	300 MW
Backlog	NOK 15 mill	NOK 747 mill
Active sales pipeline	1.5 GW	18.5 GW
# of employees	10	165 <sup>1</sup>
Listing venue	Euronext Growth	Oslo Børs main market

1) As of 7 February 2023

Hydrogen pro

Complete product delivery for ACES<sup>1</sup> Project

Expand footprint

Increase order backlog

Secure > 1 GW additional manufacturing capacity

Final verification of 3rd Gen electrode



# FEED study near completion at DG Fuels project in Louisiana - Final Investment Decision (FID) expected in 2023

- HydrogenPro is chosen as the supplier for high-pressure alkaline electrolyzers for DG Fuels' plant in Louisiana
- HydrogenPro's contract with DG Fuels is worth >USD 500 million, excluding life cycle services
- DG Fuels has sold out 100% of the expected initial production at the Louisiana plant in the US

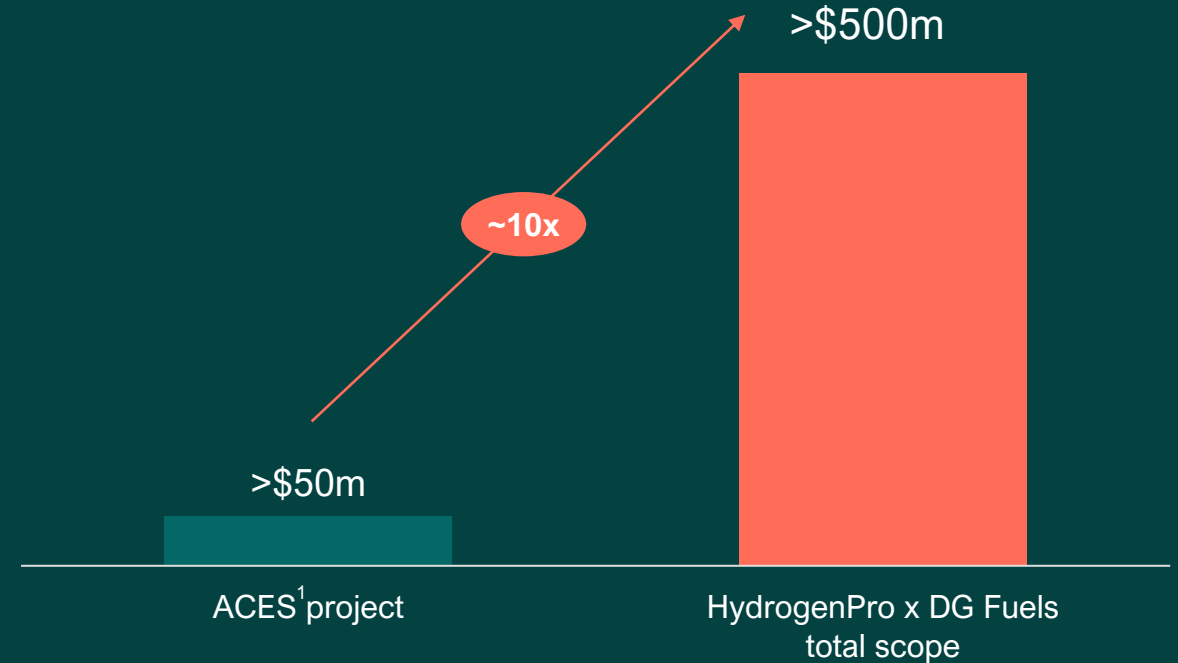

# Progressing on delivery to ACES<sup>1</sup> project: the world's largest green hydrogen energy hub

- 220 MW electrolysis plant
- HydrogenPro has also signed a 10-year service and support agreement
- The Advanced Clean Energy Storage Hub will use renewable energy sources
- HydrogenPro will complete the manufacturing of the electrolyser systems in H2 2023, followed by on-site work with completion in late 2024

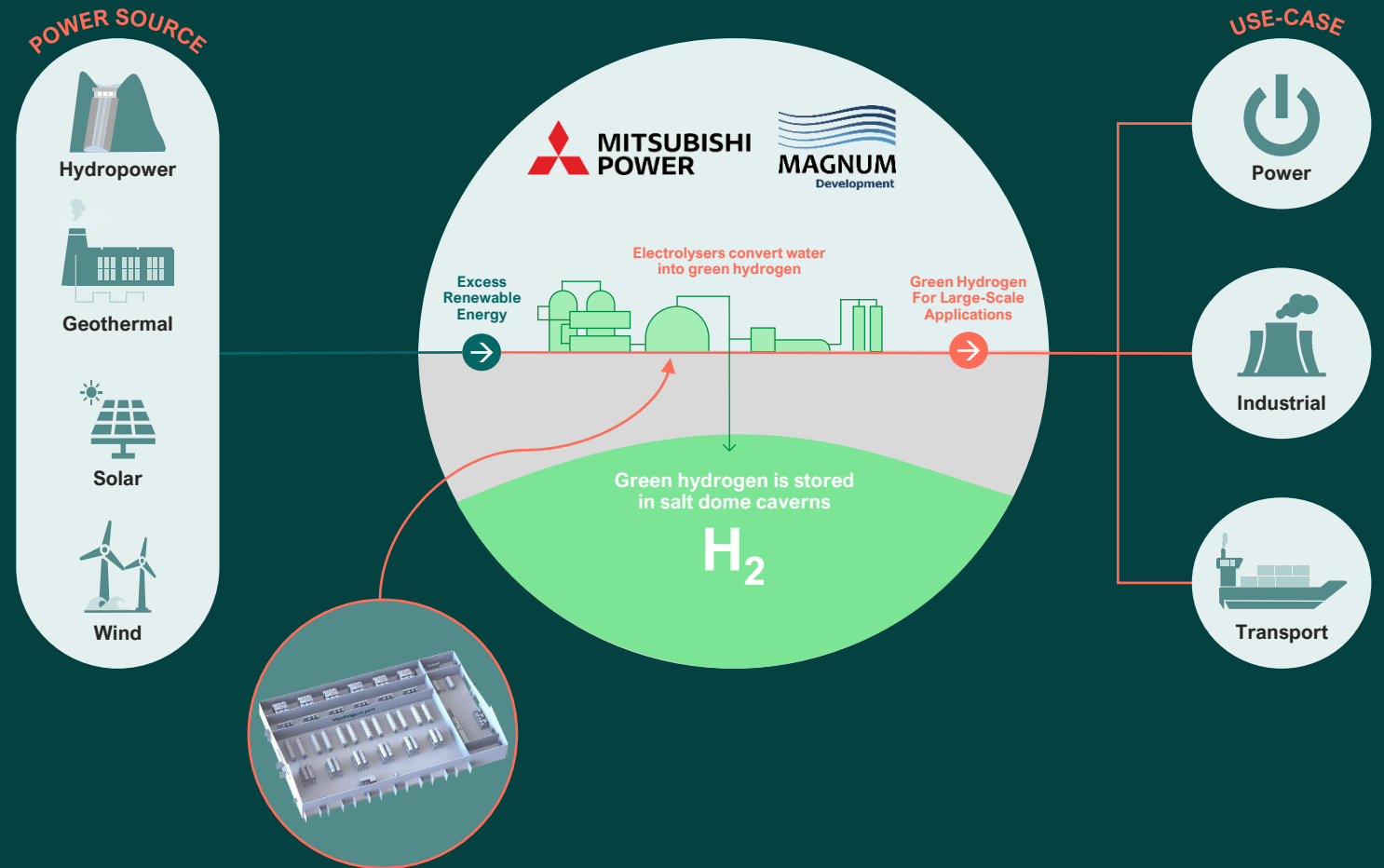

1) Advanced Clean Energy Storage



# Current footprint – building a global brand

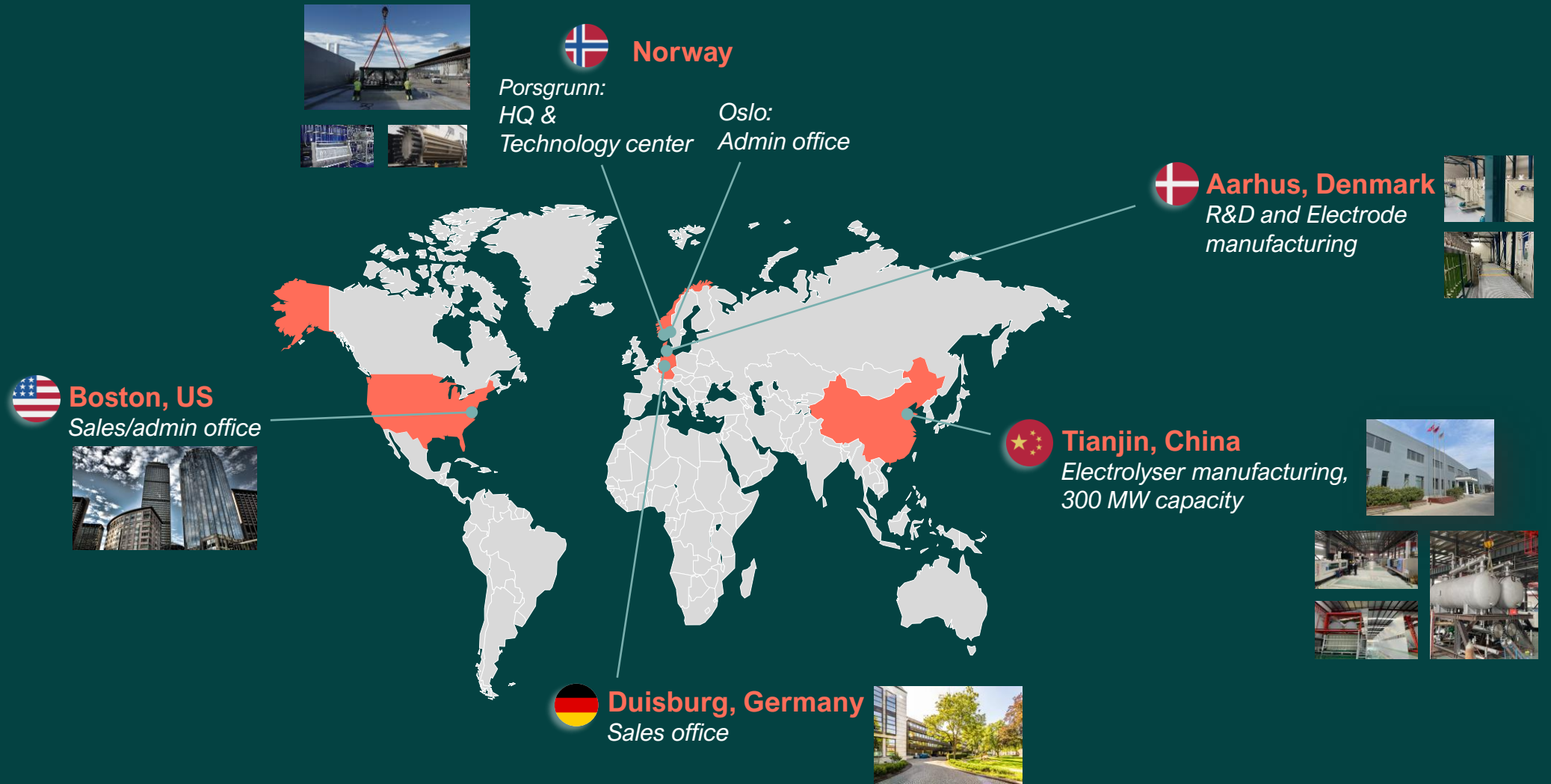

# Focused investment plan to *scale up globally* and generate *industry-leading returns*

## Focused capital deployment plan

- Global manufacturing & assembly capacity
- Technology and innovation front-runner
- Scale-up of the organisation
- Working capital on large-scale projects

## Main short-term cash flow items

- Q1 2023: working capital to deliver on purchase orders
- Payments received in line with manufacturing progress
- R&D expenses and scale-up of organisation
- Growing presence in the US and Europe

*Adequate cash position at current activity level*





## II. Becoming #1 provider of large-scale green hydrogen plants

**Hydrogen pro**

# Four strategic pillars to become #1 provider of large-scale green hydrogen plants







# HydrogenPro's 3<sup>rd</sup> Gen electrode technology increases efficiency and reduces OPEX

## Levelised cost of hydrogen

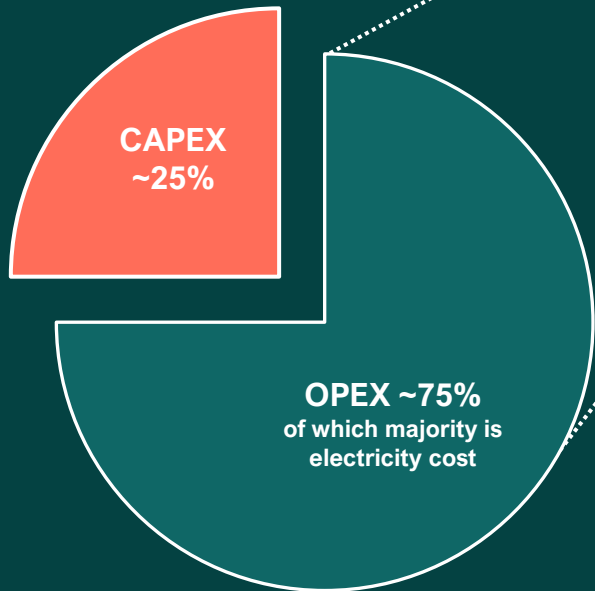

## Near-term R&D priorities to reduce end-user OPEX

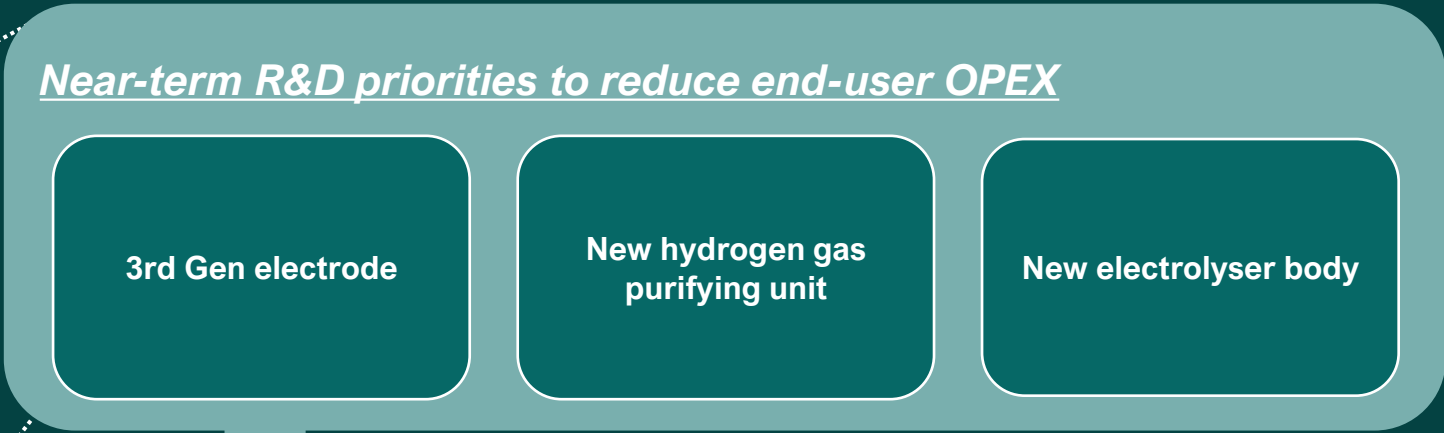

**Advanced electrodes is a *game changer* for production of green hydrogen**

- HydrogenPro's 3<sup>rd</sup> Gen technology reduces consumption of electricity by 14%
- Increasingly higher advantage with high energy prices
- Significant reduction of cooling water need



# Expanding our presence

## Pillars of HydrogenPro's global expansion strategy:

- Develop organisational flexibility to serve each individual region
  - HydrogenPro, JVs, licensing, other partnership models
- Dynamic, flexible supply chain and logistics
  - Develop local supply chains, secure service and aftersales, reduce cost from shipping, tolls and fees, and secure national political support
- Currently preparing expansion of footprint in Europe, North America and MENA

***Electrolysis capacity target of >5 GW p.a. within five years***

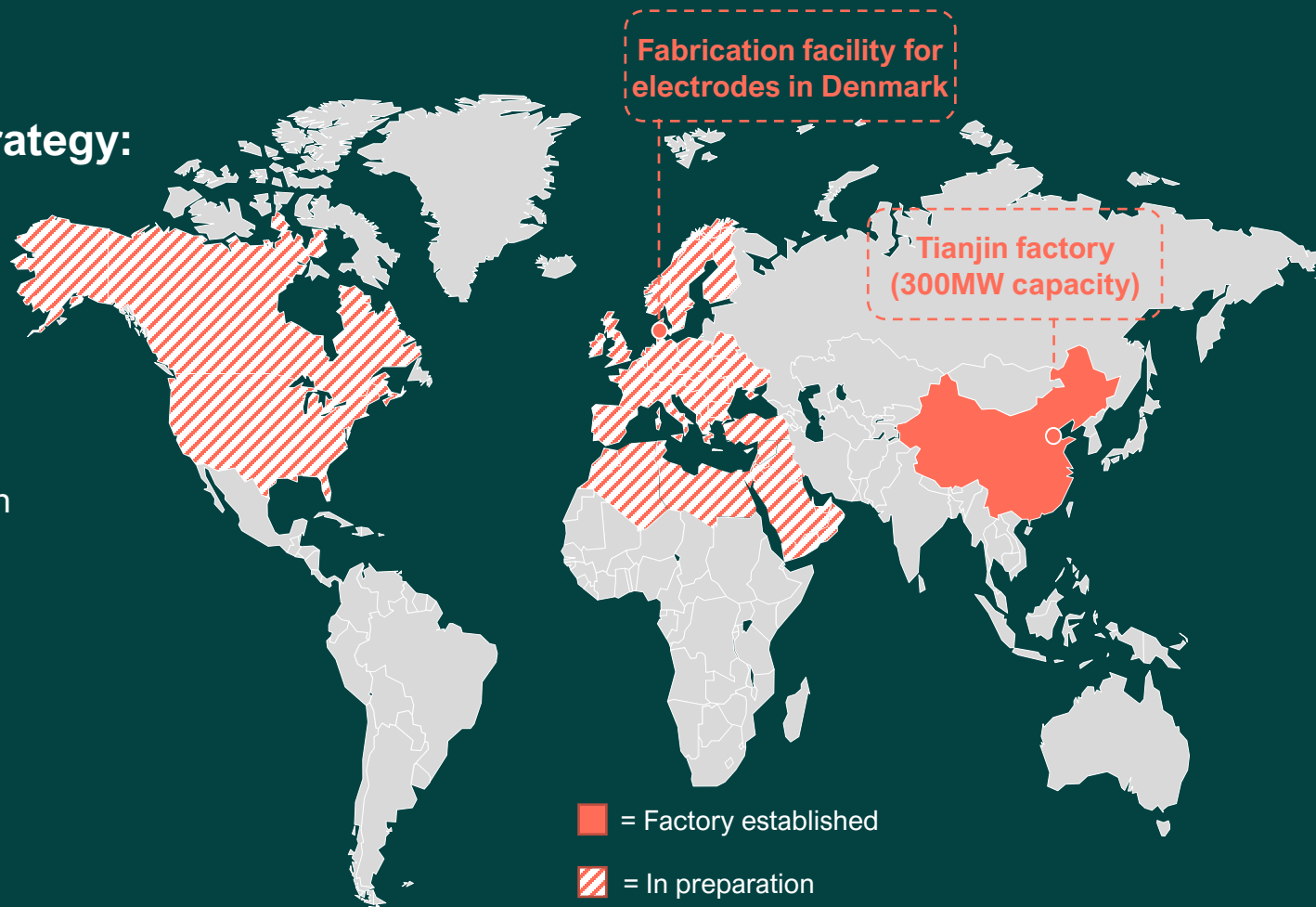





# Increased momentum for green hydrogen in the US

Inflation Reduction Act (IRA) was signed into law on August 16, 2022

IRA boosts demand for clean hydrogen<sup>1</sup>

**\$3/kg H<sub>2</sub>**

in tax credits for producers of green hydrogen

Wind/solar/hydro power is a pre-requisite to maximise tax credit

High-pressure alkaline or PEM electrolysis

Low carbon hydrogen<sup>2</sup> final energy demand by end use  
(million metric tons per year)

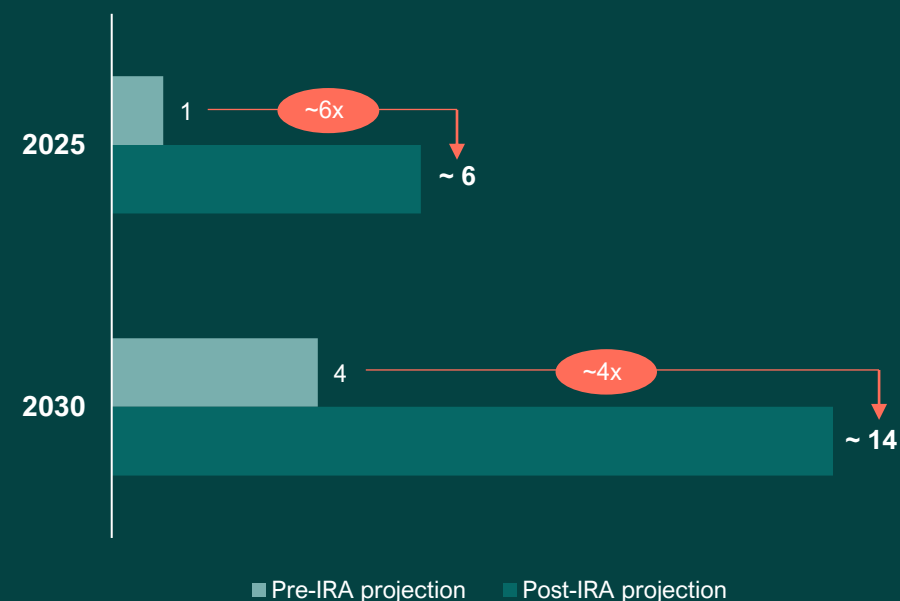

Tax incentives and clean H<sub>2</sub> demand makes HydrogenPro's high-pressure alkaline electrolyzers attractive for US market



# A scalable and flexible business model combined with a scalable and modular product offering

## Turn-key process plant

Standardised core scope manufactured by  
**Hydrogen pro**

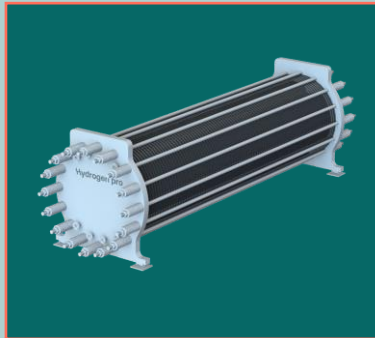

Electrolyser stacks



Gas separator skids

Scope delivered together with partners

Electro

Auxiliary systems

EPC

- Scope delivered with large industrial partners like Mitsubishi and ABB
- Targeting additional strategic partnerships going forward



# Life cycle model increases recurring revenues

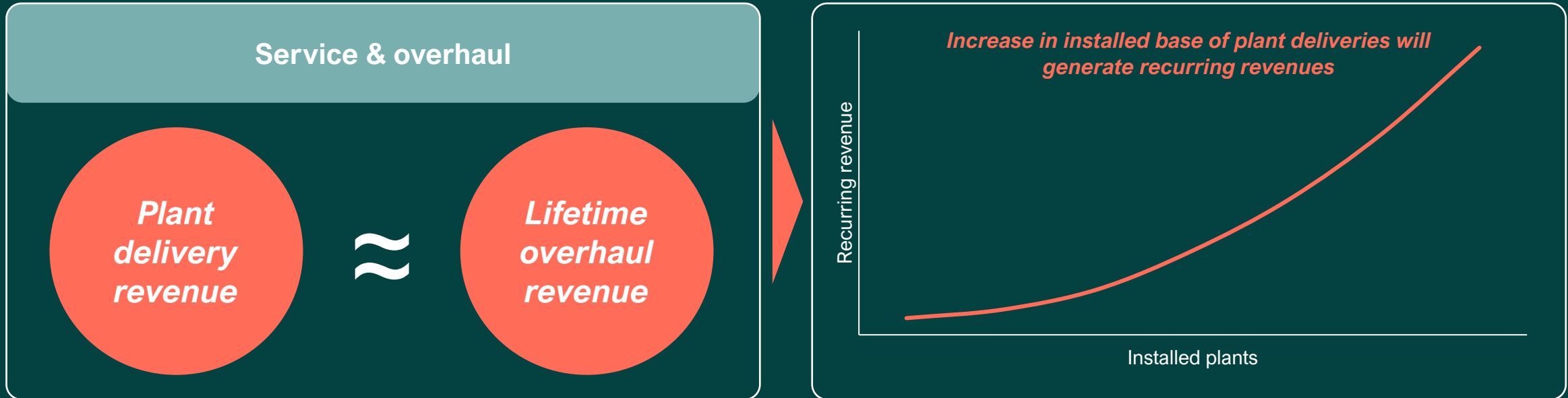

Significant potential for *additional* after-sales revenues

- Remote and digital services
- Rapid response support
- Product optimisation
- Predictive modelling





## III. Summary

Hydrogen pro

# Q4 2022 - Executive summary



Proof-of-concept for world's largest electrolyser

Backlog of NOK 747 mill.

Offtake agreements on entire volume for DG Fuels' SAF plant in Louisiana secured. Estimated FID in 2023 - value to HydrogenPro is >USD 500 million

Global electrolysis capacity target of >5 GW p.a. within five years

Significant up-lift in revenues from ACES<sup>1</sup> project, starting from Q1 2023

## Hydrogen pro

Pure Performance | Pure Efficiency | Pure **Power**



# Q&A



# IV. Appendix

# HydrogenPro delivers large-scale green hydrogen plants

## Hydrogen pro

Renewables

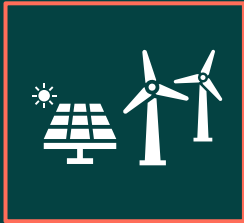

Water

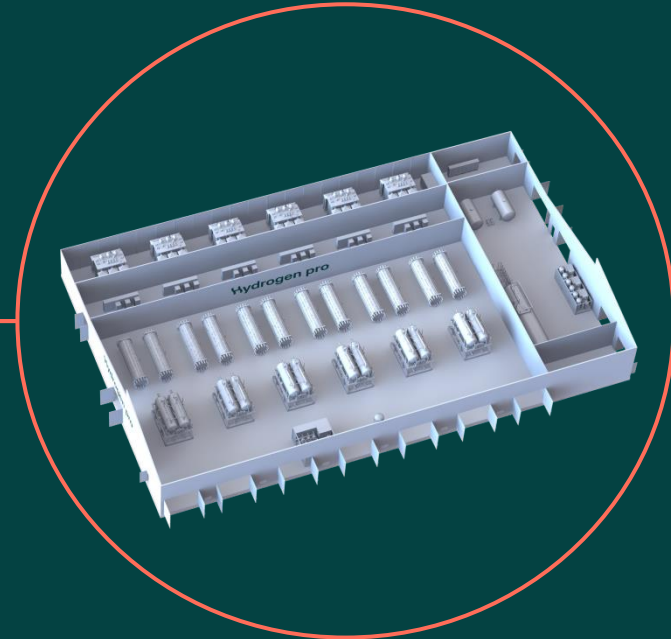
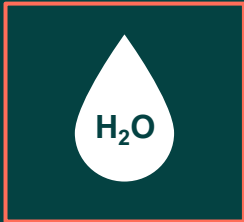

LARGE-SCALE  
HYDROGEN PLANTS

HydrogenPro delivers

World-class R&D resulting in  
market leading efficiency  
& optimised Balance of Plant

Client receives

Best-in-class OPEX and  
CAPEX





# Hydrogen pro

[www.hydrogen-pro.com](http://www.hydrogen-pro.com)